



780 Professional Drive N. Shreveport, LA 71105 Phone (318)-524-2270 Fax (318)-524-2297  
www.highlifter.com

## **Polaris RZR 900 Trail 50”**

### Read before Installation

This product is designed for use on ATVs and/or RUVs to increase ground clearance and fender clearance. Purchasers should be aware that use of this product may increase the frequency of required maintenance, part wear, and will raise the center of gravity on your ATV and/or RUV, increasing risk of roll-over, injury and death on all types of terrain. It is your responsibility to always inform other operators and passengers of this vehicle about the added risks.

High Lifter Products, products are designed to best fit users ATV/RUV under stock conditions. Adding, modifying, or fabricating any OEM or aftermarket parts will void warranty. High Lifter Products, products could interfere with other aftermarket accessories. If the user has aftermarket products on machine, contact High Lifter Products to verify that they will work together. Adding aftermarket suspension components and/or more aggressive tires can cause breakage of other OEM driveline components such as differentials, axles or drive shafts.

We recommend that wider tires and/or wheel spacers be used to achieve a wider stance and to improve stability of the ATV and/or RUV. Riders should be advised that the handling characteristics of a taller ATV and/or RUV are different and require extra care when riding, particularly on side hills or off-camber situations. If you further raise the center of gravity by adding taller tires, heavy loads to racks or seats, or by any other means, the ATV and/or RUV must be operated with even more care, at slower speeds and on relatively flat ground. All turns should be done at a slow speed, even on level ground.

Operation of an ATV and/or RUV with or without modified suspension components, while or shortly after consuming alcohol or drugs, subjects the rider to the risk of serious bodily harm or possible death. This risk is compounded if the rider does not wear an approved helmet and other safety gear. High Lifter urges that all approved safety gear be worn when riding an ATV and/or RUV as a driver or passenger.

By purchasing and installing High Lifter Products, products, user agrees that should damages occur, High Lifter Products will not be held responsible for loss of time, use, labor fees, replacement parts, or freight charges. High Lifter Products will not be held responsible for any direct, indirect, incidental, special, or consequential damages that result from any product purchased from High Lifter Products. The total liability of seller to user for all damages, losses, and causes of action, shall not exceed the total purchase price paid for the product that gives rise to the claim.

### Dealers and other Installers

You are responsible for informing your customer and end user of the information contained above and the increased potential hazards of operating an ATV and/or RUV equipped with modified suspension components. If you install any suspension modifying components, it is your responsibility to also install the warning label prominently in view of the driver and in prominent view of the driver and passenger on RUVs and multi-passenger ATVs. They should also be instructed to notify anyone operating the vehicle, as well as any passengers, that said vehicle is modified.

As discussed above, it is critically important that they be instructed in the need for slower speed operation, regardless of terrain, after this lift kit is installed.

## Parts Diagrams

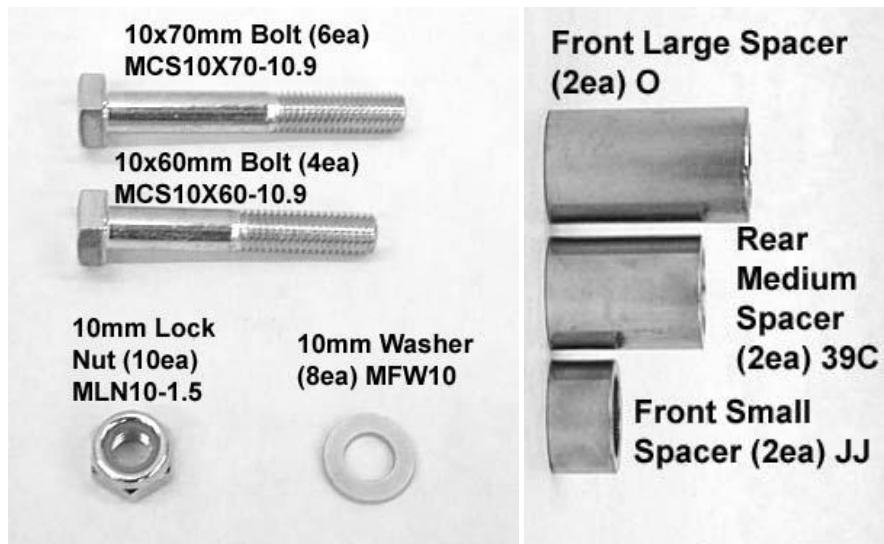
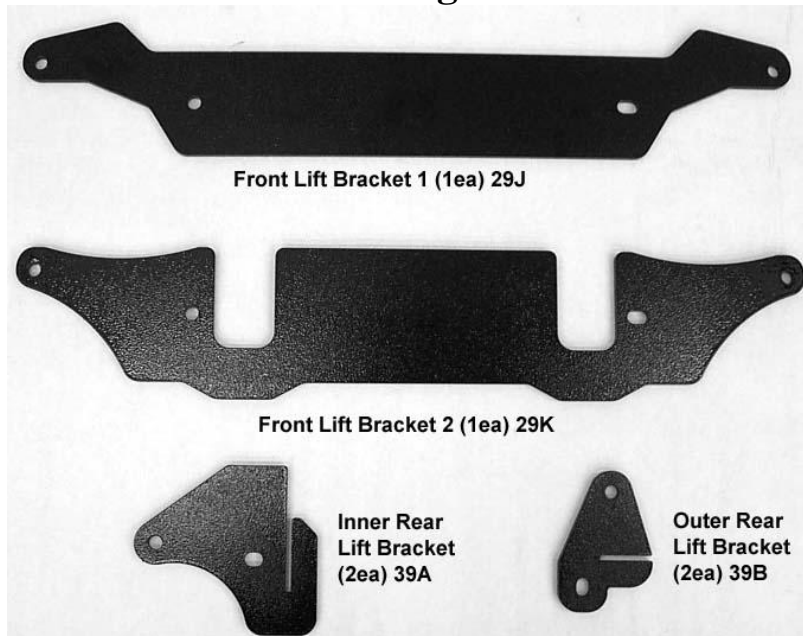

**NOTE:** Group all the spacers together by size, this will make installation easier. The largest and smallest are used on the front and remaining are used in the rear.

## Front Lift Installation

**NOTE: The photo illustrations may not look exactly like your RZR, the one in the photos has gas shocks, but the installation is the same.**

1. Place transmission in park. Place jack under center of front end and lift until front wheels clear the ground. Be careful to properly secure and support so that A-arms and shocks can droop to full extension.
2. Remove front wheels.
3. Open the hood and you will need to reroute the headlight wires. Currently they run up from below the cross member on frame and connect to the lights.

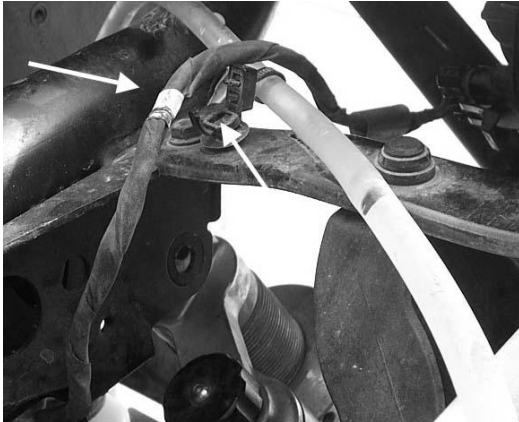

4. Run the wires behind the cross member on the frame and reconnect to the lights.

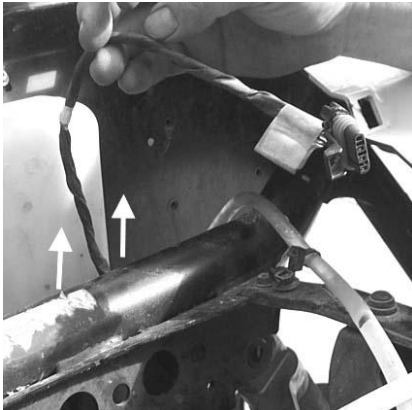

5. Disconnect the top of the front shocks.



6. Next insert the long front lift plate in front of the front cross member. Insert it through the hood opening.

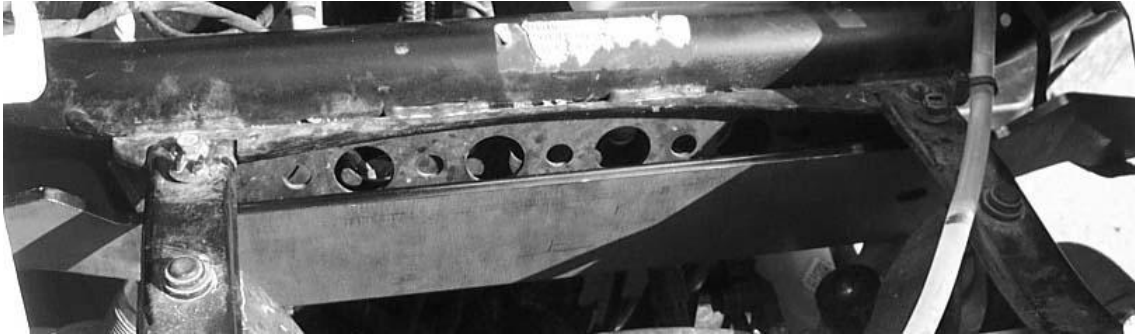

7. Insert the 10 x 70mm bolt through the bracket, placing a 10mm washer between the bracket and the shock mount.

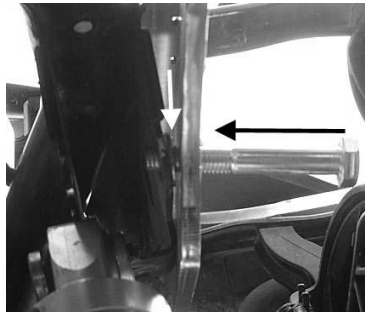

8. Next insert **Front Large Spacer** in the stock shock mount position and push the 10x70mm bolt through. Repeat steps for the opposite side at this time.



9. Insert the front slotted bracket on the backside of the front cross member.



10. Connect the bracket to the frame by placing it on the bolts and fasten it using the 10mm lock nuts provided.



11. Connect the top of the shock to the lift plates. Insert the 10 x 70mm hex bolt through from the backside forward. Place a small **Front Small Spacer** between the shock eyelet and the lift plate. Fasten it tight using a 10mm lock nut provided.

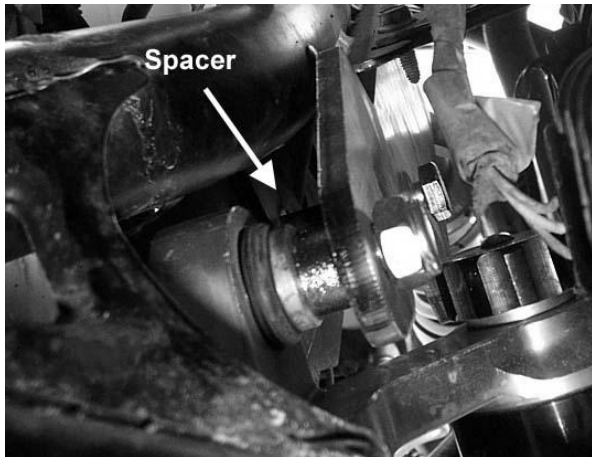
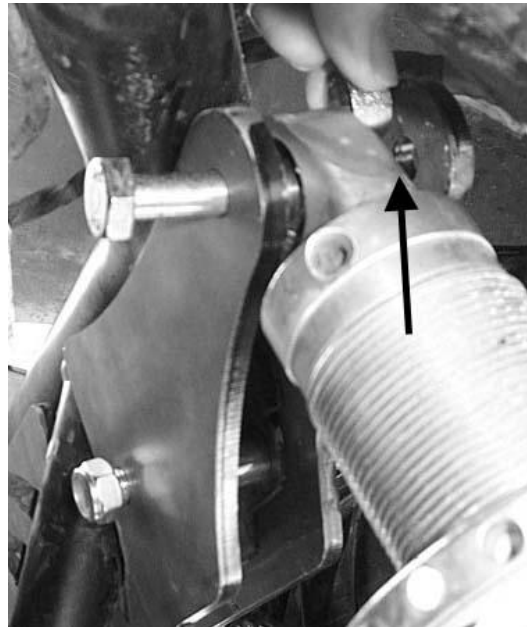

12. Repeat steps for opposite side and tighten all nuts and bolts.
  13. To get the maximum amount of lift possible you will need to adjust your shocks to the highest setting possible on the front and rear.
  14. Place wheels back on the ATV, torque all lugs to factory specifications.
- NOTE: Double check all bolts to verify they are tight. Loose bolts come off and can cause a crash and serious injury or death.**

## Rear Lift Installation

1. Place UTV transmission in park. Lift the rear of the RZR until the rear trailing arms drop to full extension and tires leave the ground.
2. You will need to remove the rear wheels
3. Disconnect the top of the rear shock from the shock tabs.
4. Starting from the driver's side, rear left from the seated position, insert the inner left bracket into place **between the shock mount tabs**.

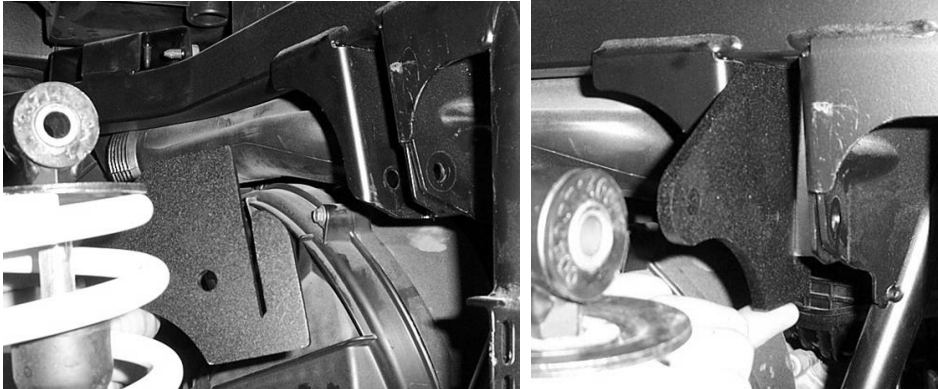

5. Now connect the bracket to the frame by inserting the 10x60mm bolt through the frame shock mount tab, then through the bracket. Insert the **Rear Medium** between the plate and the shock mount tab. Push the bolt through the spacer and tab.

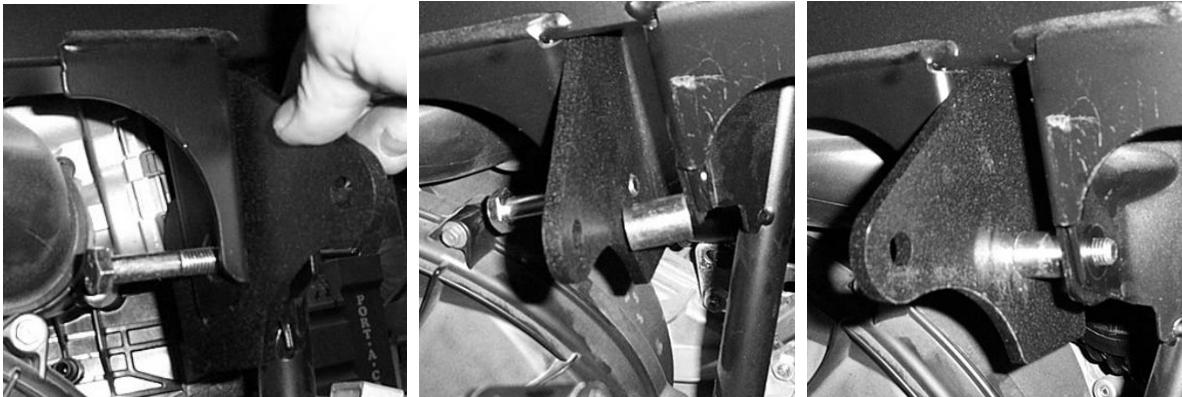

6. Now place the left outer bracket in place. Loosely connect it using the 10mm lock nut.

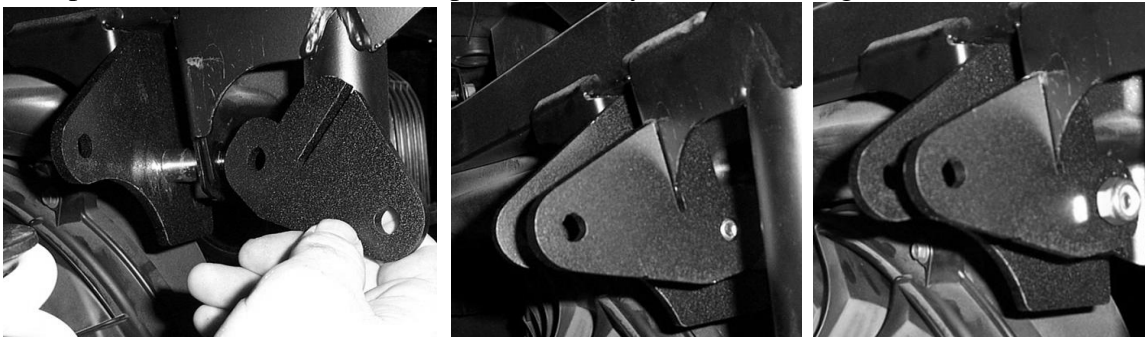

7. Connect the top of the shock to the brackets using the 10x60mm bolt and 10mm lock nut provided. Place 10mm washers on either side of the shock eye between the eye and brackets.

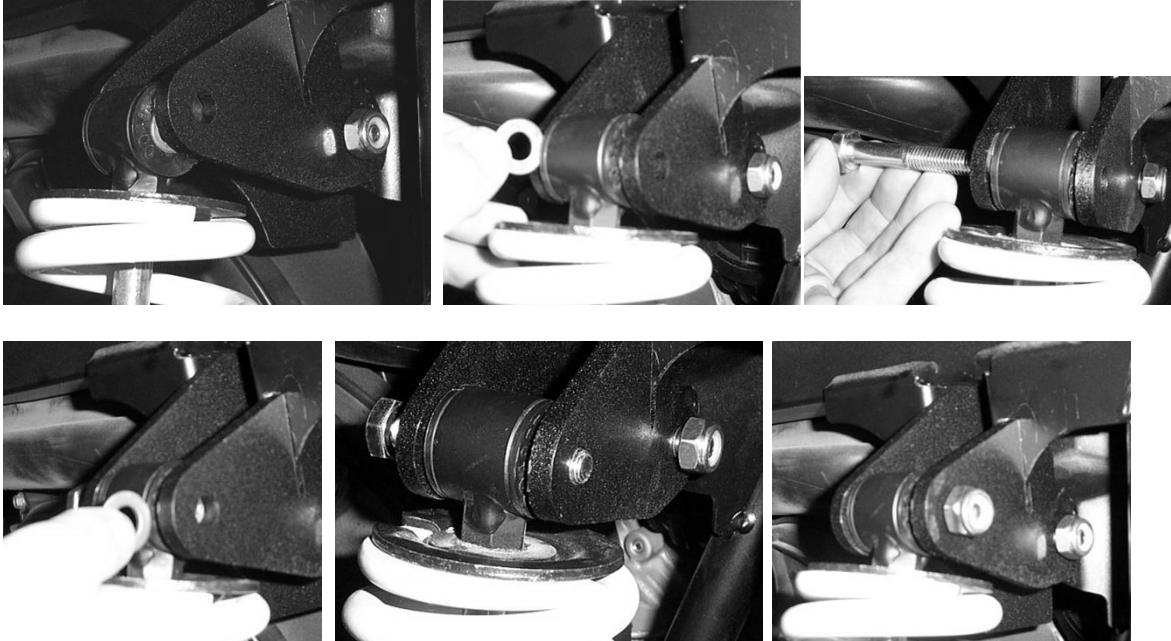

8. Tighten all nuts and bolts.
9. Repeat steps for opposite side.
10. To get the maximum amount of lift possible you will need to adjust your shocks to the highest setting possible on the front and rear.
11. Place wheels back on the ATV, torque all lugs to factory specifications.

**NOTE: Double check all bolts to verify they are tight. Loose bolts come off and can cause a crash and serious injury or death.**



## High Lifter Name Plate Installation

1. In the rear you will need to remove the plastic.

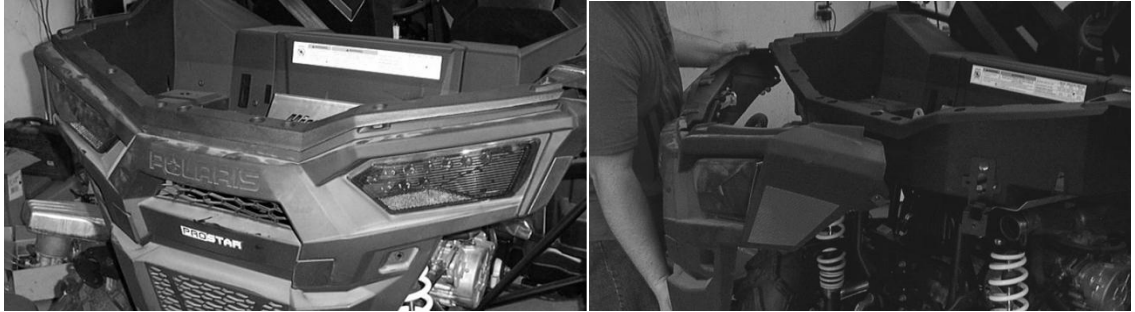

2. Place the High Lifter logo badge over the plastic honey comb opening. You will need to bend the plate to fit the contour of the plastic.

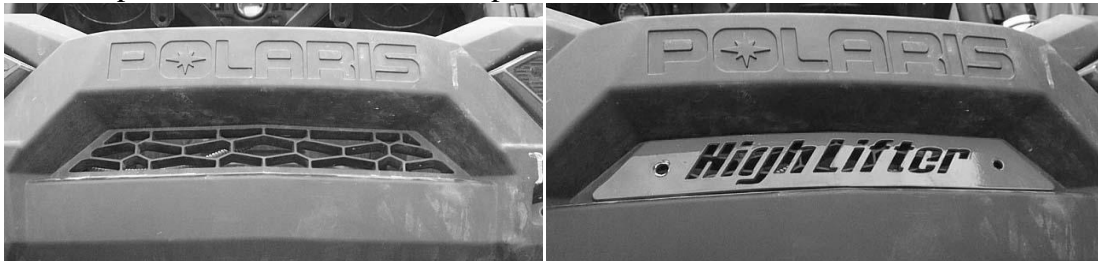

3. Using the two button head bolts, washers, and lock nuts to connect the plate to the plastic.



4. Place the plastic back on the RZR.



**Thank You**  
**For choosing**

***High Lifter***  
**PRODUCTS**



### **High Lifter Lifetime Warranty**

From the beginning, High Lifter has engineered and manufactured some of the toughest, most durable products on the market. That's why this product comes with a Lifetime Warranty. It's our promise that High Lifter will never let you down.

- The **Lifetime Warranty** covers products sold to the original purchaser only and is not transferable. The term of the warranty is for the lifetime of the vehicle in question.
- Normal wear and tear items and finishes, such as, but not limited to: Heim joints, tie rod ends, ball joints, bearings, seals, bushings, bushing sleeves, zinc plating , powder coating, or chipping and discoloration of any finish is not covered.
- High Lifter will ship the replacement product after the returned product has been inspected by High Lifter staff.
- The warranty shall not include claims for damages, installation time or labor charges, economic losses, inconvenience, transportation, towing, down time, direct or indirect or consequential damages or delay resulting from any defect.
- The warranty does not apply to products that have been improperly applied or improperly installed.

### **Making a warranty claim**

1. All claims must be accompanied by the part and the original sales receipt or other acceptable proof of purchase from the original owner.
2. All warranties must be accompanied with a Return Merchandise Authorization (RMA) number. (Contact High Lifter at 318-524-2270 or 800-699-0947 for an RMA number)
3. When shipping the damaged product:
  - a. Write the RMA number on the outside of the box.
  - b. Also include the RMA number, proof of purchase and any notes inside the box.
  - c. Please keep your tracking number and shipment information.
4. The customer is responsible for shipping the product to High Lifter--return shipping within the lower 48 states will be paid by High Lifter products. With all warranty claims, only standard shipping services apply.
5. High Lifter will process your order within 24 business hours of receiving the returned item.
6. **Ship to:** High Lifter Products, 780 Professional Drive North, Shreveport, Louisiana 71105